

# OWNER'S MANUAL



## Heat Pump Air To Air Split Air Conditioner ARCTIC NG Series







**CH-S09FTXLA2-NG**  
**CH-S12FTXLA2-NG**  
**CH-S18FTXLA2-NG**  
**CH-S24FTXLA2-NG**

For proper operation, please read and keep this manual carefully.  
Designed by Cooper&Hunter International Corporation, FL Miami, USA

[www.cooperandhunter.com](http://www.cooperandhunter.com)

---

## EXPLANATION OF SYMBOLS

 <b>WARNING</b> 	This symbol indicates the possibility of death or serious injury.
 <b>CAUTION</b> 	This symbol indicates the possibility of injury or damage to property.
 <b>NOTICE</b>	Indicates important but not hazard-related information, used to indicate risk of property damage.

## EXCEPTION CLAUSES

Manufacturer will bear no responsibilities when personal injury or property loss is caused by the following reasons:





1. Damage the product due to improper use or misuse of the product;
2. Alter, change, maintain or use the product with other equipment without abiding by the instruction manual of manufacturer;
3. After verification, the defect of product is directly caused by corrosive gas;
4. After verification, the defects are due to improper operation during transportation of product;
5. Operate, repair, maintain the unit without abiding by instruction manual or related regulations;
6. After verification, the problem or dispute is caused by the quality specification or performance of parts and components that produced by other manufacturers;
7. The damage is caused by natural calamities, bad using environment or force majeure.

If it needs to install, move or maintain the air conditioner, please contact dealer or local service center to conduct it at first. Air conditioner must be installed, moved or maintained by appointed unit. Otherwise, it may cause serious damage or personal injury or death.

When refrigerant leaks or requires discharge during installation, maintenance, or disassembly, it should be handled by certified professionals or otherwise in compliance with local laws and regulations.

This appliance is not intended for use by persons (including children) with reduced physical, sensory or mental capabilities or lack of experience and knowledge, unless they have been given supervision or instruction concerning the use of the appliance by a person responsible for their safety. Children should be supervised to ensure that they do not play with the appliance.

## REFRIGERANT

 <p>Appliance filled with flammable gas R32.</p>	 <p>Before install the appliance, read the installation manual first.</p>
 <p>Before use the appliance, read the owner's manual first.</p>	 <p>Before repair the appliance, read the service manual first.</p>

- To realize the function of the air conditioner unit, a special refrigerant circulates in the system. The used refrigerant is the fluoride R32, which is specially cleaned. The refrigerant is flammable and inodorous. Furthermore, it can lead to explosion under certain conditions. But the flammability of the refrigerant is very low. It can be ignited only by fire.
- Compared to common refrigerants, R32 is a nonpolluting refrigerant with no harm to the ozonosphere. The influence upon the greenhouse effect is also lower. R32 has got very good thermodynamic features which lead to a really high energy efficiency. The units therefore need a less filling.



### WARNING



Do not use means to accelerate the defrosting process or to clean, other than those recommended by the manufacturer. Should repair be necessary, contact your nearest authorized Service Centre. Any repairs carried out by unqualified personnel may be dangerous. The appliance shall be stored in a room without continuously operating ignition sources. (for example: open flames, an operating gas appliance or an operating electric heater.) Do not pierce or burn. Appliance shall be installed, operated and stored in a room with a floor area larger than  $Xm^2$ .

(Please refer to table «a» in section of «Safety operation of flammable refrigerant» for space X.) Appliance filled with flammable gas R32. For repairs, strictly follow manufacturer's instructions only. Be aware that refrigerants may not contain an odor. Read specialist's manual.



This appliance is not intended for use by persons (including children) with reduced physical, sensory or mental capabilities, or lack of experience and knowledge, unless they have been given supervision or instruction concerning use of the appliance by a person responsible for their safety. Children should be supervised to ensure that they do not play with the appliance.

Hereby, Our company, declares that this Air Conditioner is in compliance with the essential requirement and other relevant provisions of RE Directive 2014/53/EU. A copy of the full DoC is attached. Wireless frequency range: 2412MHz – 2472MHz Maximum Transmit Power: 18dBm

### R32: 675



This marking indicates that this product should not be disposed with other household wastes.

To prevent possible harm to the environment or human health from uncontrolled waste throughout the EU. To prevent possible harm to the environment or human health.

From uncontrolled waste disposal, recycle it responsibly to promote the sustainable reuse of material resources. To return your used device, please use the return and collection systems or contact the retailer where the product was purchased. They can take this product for environmental safe recycling. If it needs to install, move or maintain the air conditioner, please contact dealer or local service center to conduct it at first. Air conditioner must be installed, moved or maintained by appointed unit. Otherwise, it may cause serious damage or personal injury or death.

## SAFETY OPERATION OF FLAMMABLE REFRIGERANT

### Qualification requirement for installation and maintenance man

- ▷ All the work men who are engaging in the refrigeration system should bear the valid certification awarded by the authoritative organization and the qualification for dealing with the refrigeration system recognized by this industry. If it needs other technician to maintain and repair the appliance, they should be supervised by the person who bears the qualification for using the flammable refrigerant.
- ▷ It can only be repaired by the method suggested by the equipment's manufacturer.

### Installation notes

- ▷ The air conditioner must be installed in a room that is larger than the minimum room area. The minimum room area is shown on the nameplate or following table a.
- ▷ It is not allowed to drill hole or burn the connection pipe.
- ▷ Leak test is a must after installation.

**Table A - Minimum room area (m<sup>2</sup>)**

Charge amount (kg)	Floor location	Window mounted	Wall mounted	Ceiling mounted
≤1.2	/	/	/	/
1.3	14.5	5.2	1.6	1.1
1.4	16.8	6.1	1.9	1.3
1.5	19.3	7	2.1	1.4
1.6	22	7.9	2.4	1.6
1.7	24.8	8.9	2.8	1.8
1.8	27.8	10	3.1	2.1
1.9	31	11.2	3.4	2.3
2	34.3	12.4	3.8	2.6
2.1	37.8	13.6	4.2	2.8
2.2	41.5	15	4.6	3.1
2.3	45.4	16.3	5	3.4
2.4	49.4	17.8	5.5	3.7
2.5	53.6	19.3	6	4

### Maintenance notes

- ▷ Check whether the maintenance area or the room area meet the requirement of the nameplate.
  - It's only allowed to be operated in the rooms that meet the requirement of the nameplate.
- ▷ Check whether the maintenance area is well-ventilated.
  - The continuous ventilation status should be kept during the operation process.
- ▷ Check whether there is fire source or potential fire source in the maintenance area.
  - The naked flame is prohibited in the maintenance area; and the "no smoking" warning board should be hanged.
- ▷ Check whether the appliance mark is in good condition.
  - Replace the vague or damaged warning mark.

### Welding

- ▷ If you should cut or weld the refrigerant system pipes in the process of maintaining, please follow the steps as below:
  - A. Shut down the unit and cut power supply
  - B. Eliminate the refrigerant
  - C. Vacuuming
  - D. Clean it with N<sub>2</sub> gas
  - E. Cutting or welding
  - F. Carry back to the service spot for weldin
- ▷ The refrigerant should be recycled into the specialized storage tank.
- ▷ Make sure that there isn't any naked flame near the outlet of the vacuum pump and it's wellventilated.

## Filling the refrigerant

- ▷ Use the refrigerant filling appliances specialized for R32. Make sure that different kinds of refrigerant won't contaminate with each other.
- ▷ The refrigerant tank should be kept upright at the time of filling refrigerant.
- ▷ Stick the label on the system after filling is finished (or haven't finished).
- ▷ Don't overfilling.
- ▷ After filling is finished, please do the leakage detection before test running; another time of leak detection should be done when it's removed.

## Safety instructions for transportation and storage

- ▷ Please use the flammable gas detector to check before unload and open the container.
- ▷ No fire source and smoking.
- ▷ According to the local rules and laws.

## SAFETY PRECAUTIONS



### WARNING



### Installation

- ▷ Installation or maintenance must be performed by qualified professionals.
- ▷ The appliance shall be installed in accordance with national wiring regulations. According to the local safety regulations, use qualified power supply circuit and circuit breaker.
- ▷ All wires of indoor unit and outdoor unit should be connected by a professional. Be sure to cut off the power supply before proceeding any work related to electricity and safety.
- ▷ Make sure the power supply matches with the requirement of air conditioner.
- ▷ Unstable power supply or incorrect wiring may result in electric shock, fire hazard or malfunction. Please install proper power supply cables before using the air conditioner.
- ▷ The grounding resistance should comply with national electric safety regulations.

- ▷ Air Conditioner should be properly grounded. Incorrect grounding may cause electric shock.
- ▷ Do not put through the power before finishing installation.
- ▷ Do install the circuit breaker. If not, it may cause malfunction.
- ▷ An all-pole disconnection switch having a contact separation of at least 3mm in all poles should be connected in fixed wiring.
- ▷ Circuit breaker should be included magnet buckle and heating buckle function. It can protect the overload and circuitshort.



### CAUTION



- ▷ Instructions for installation and use of this product are provided by the manufacturer.
- ▷ Select a location which is out of reach for children and far away from animals or plants. If it is unavoidable, please add the fence for safety purpose.
- ▷ The indoor unit should be installed close to the wall. Don't use unqualified power cord.
- ▷ If the length of power connection wire is insufficient, please contact the supplier for a new one.
- ▷ The appliance must be positioned so that the plug is accessible.
- ▷ For the air conditioner with plug, the plug should be reachable after finishing installation.
- ▷ For the air conditioner without plug, a circuit breaker must be installed in the line.
- ▷ The yellow-green wire in air conditioner is grounding wire, which can't be used for other purposes. The air conditioner is the first class electric appliance. It must be properly grounded with specialized grounding device by a professional. Please make sure it is always grounded effectively, otherwise it may cause electric shock.
- ▷ The temperature of refrigerant circuit will be high, please keep the interconnection cable away from the copper tube.

## SAFETY PRECAUTIONS



### WARNING



#### Operation and Maintenance

- ▷ This appliance can be used by children aged from 8 years and above and persons with reduced physical, sensory or mental capabilities or lack of experience and knowledge if they have been given supervision or instruction concerning use of the appliance in a safe way and understand the hazards involved.
  - ▷ Children shall not play with the appliance.
  - ▷ Cleaning and user maintenance shall not be made by children without supervision.
  - ▷ If the supply cord is damaged, it must be replaced by the manufacturer, its service agent or similarly qualified persons in order to avoid a hazard.
  - ▷ Do not connect air conditioner to multi-purpose socket. Otherwise, it may cause fire hazard.
  - ▷ Do disconnect power supply when cleaning air conditioner. Otherwise, it may cause electric shock. Do not wash the air conditioner with water to avoid electric shock.
  - ▷ Do not spray water on indoor unit. It may cause electric shock or malfunction. Do not repair air conditioner by yourself. It may cause electric shock or damage. Please contact dealer when you need to repair air conditioner.
  - ▷ After removing the filter, do not touch the fins to avoid injury.
  - ▷ Do not extend fingers or objects into air inlet or air outlet. It may cause personal injury or damage.
  - ▷ Do not spill water on the remote controller, otherwise the remote controller may be broken.
  - ▷ Do not use fire or hair dryer to dry the filter to avoid deformation or fire hazard. Do not block air outlet or air inlet. It may cause malfunction.
- ▷ Do not step on top panel of outdoor unit, or put heavy objects. It may cause damage or personal injury. When below phenomenon occurs, please turn off air conditioner and disconnect power immediately, and then contact the dealer or qualified professionals for service:
    - ▷ Power cord is overheating or damaged.
    - ▷ There's abnormal sound during operation.
    - ▷ Circuit breaker trips off frequently.
    - ▷ Air conditioner gives off burning smell.
    - ▷ Indoor unit is leaking.

## INSTALLATION NOTICE

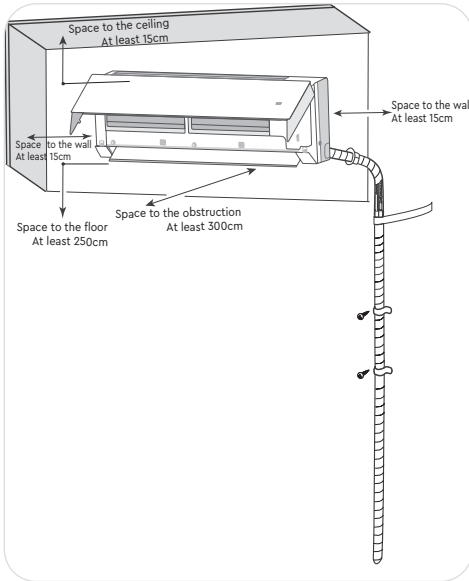

### Safety precautions for installing and relocating the unit

To ensure safety, please be mindful of the following precautions.



#### WARNING



- ▷ When installing or relocating the unit, be sure to keep the refrigerant circuit free from air or substances other than the specified refrigerant.

Any presence of air or other foreign substance in the refrigerant circuit will cause system pressure rise or compressor rupture, resulting in injury.

- ▷ When installing or moving this unit, do not charge the refrigerant which is not comply with that on the nameplate or unqualified refrigerant.

Otherwise, it may cause abnormal operation, wrong action, mechanical malfunction or even serious safety accident.

- ▷ When refrigerant needs to be recovered during relocating or repairing the unit, be sure that the unit is running in cooling mode. Then, fully close the valve at high



#### WARNING



pressure side (liquid valve). About 30–40 seconds later, fully close the valve at low pressure side (gas valve), immediately stop the unit and disconnect power. Please note that the time for refrigerant recovery should not exceed 1 minute.

If refrigerant recovery takes too much time, air may be sucked in and cause pressure rise or compressor rupture, resulting in injury.

- ▷ During refrigerant recovery, make sure that liquid valve and gas valve are fully closed and power is disconnected before detaching the connection pipe.

If compressor starts running when stop valve is open and connection pipe is not yet connected, air will be sucked in and cause pressure rise or compressor rupture, resulting in injury.

- ▷ When installing the unit, make sure that connection pipe is securely connected before the compressor starts running.

If compressor starts running when stop valve is open and connection pipe is not yet connected, air will be sucked in and cause pressure rise or compressor rupture, resulting in injury.

- ▷ Prohibit installing the unit at the place where there may be leaked corrosive gas or flammable gas.

If there is leaked gas around the unit, it may cause explosion and other accidents.

- ▷ Do not use extension cords for electrical connections. If the electric wire is not long enough, please contact a local service center authorized and ask for a proper electric wire. Poor connections may lead to electric shock or fire.

- ▷ Use the specified types of wires for electrical connections between the indoor and outdoor units. Firmly clamp the wires so that their

## INSTALLATION NOTICE

### Tools for installation

1. Level meter
2. Screw driver
3. Impact drill
4. Drill head
5. Open-end wrench
6. Pipe cutter
7. Leakage detector
8. Universal meter
9. Inner hexagon spanner
10. Measuring tape
11. Pipe expander
12. Torque wrench
13. Vacuum pump
14. Pressure meter



### NOTICE

- ▷ Please contact the local agent for installation.
- ▷ Don't use unqualified power cold.

## SELECTION OF INSTALLATION LOCATION

### Basic requirement

Installing the unit in the following places may cause malfunction. If it is unavoidable, please consult the local dealer:

1. The place with strong heat sources, vapors, flammable or explosive gas, or volatile objects spread in the air.
2. The place with high-frequency devices (such as welding machine, medical equipment).
3. The place near coast area.
4. The place with oil or fumes in the air.
5. The place with sulfureted gas.
6. Other places with special circumstances.
7. The appliance shall not be installed in the laundry.
8. It's not allowed to be installed on the unstable or motive base structure (such as truck) or in the corrosive environment (such as chemical factory).

### Indoor unit

1. There should be no obstruction near air inlet and air outlet.
2. Select a location where the condensation water can be dispersed easily and won't affect other people.
3. Select a location which is convenient to connect the outdoor unit and near the power socket.
4. Select a location which is out of reach for children.
5. The location should be able to withstand the weight of indoor unit and won't increase noise and vibration.
6. The appliance must be installed 2.5 m above floor.
7. Don't install the indoor unit right above the electric appliance.
8. Please try your best to keep way from fluorescent lamp.

## SELECTION OF INSTALLATION LOCATION

### Safety precaution

1. Must follow the electric safety regulations when installing the unit.
2. According to the local safety regulations, use qualified power supply circuit and air switch.
3. Make sure the power supply matches with the requirement of air conditioner. Unstable power supply or incorrect wiring or malfunction. Please install proper power supply cables before using the air conditioner.
4. Properly connect the live wire, neutral wire and grounding wire of power socket.
5. Be sure to cut off the power supply before proceeding any work related to electricity and safety.
6. Do not put through the power before finishing installation.
7. If the supply cord is damaged, it must be replaced by the manufacturer, its service agent or similarly qualified persons in order to avoid a hazard .
8. The temperature of refrigerant circuit will be high, please keep the interconnection cable away from the copper tube.
9. The appliance shall be installed in accordance with national wiring regulations.

### Grounding requirement

1. The air conditioner is the first class electric appliance. It must be properly grounded with specialized grounding device by a professional. Please make sure it is always grounded effectively, otherwise it may cause electric shock.
2. The yellow-green wire in air conditioner is grounding wire, which can't be used for other purposes.
3. The grounding resistance should comply with national electric safety regulations.
4. The appliance must be positioned so that the plug is accessible.
5. An all-pole disconnection switch having a contact separation of at least 3 mm in all poles should be connected in fixed wiring.

## INSTALLATION OF INDOOR UNIT

### Step 1:

#### Choose installation location

Recommend the installation location to the client and then confirm it with the client.

### Step 2:

#### Install wall-mounting frame

1. Hang the wall-mounting frame on the wall; adjust it in horizontal position with the level meter and then point out the screw fixing holes on the wall.
2. Drill the screw fixing holes on the wall with impact drill (the specification of drill head should be the same as the plastic expansion particle) and then fill the plastic expansion particles in the holes.
3. Fix the wall-mounting frame on the wall with tapping screws and then check if the frame is firmly installed by pulling the frame. If the plastic expansion particle is loose, please drill another fixing hole nearby.

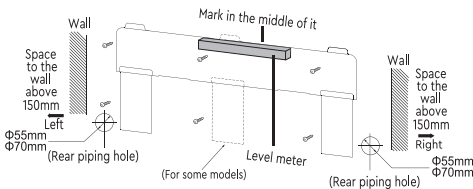

### Step 3:

#### Open piping hole

1. Choose the position of piping hole according to the direction of outlet pipe. The position of piping hole should be a little lower than the wall-mounted frame, shown as below.



### NOTICE

- ▷ The wall panel is for illustrative purposes only, please refer to the actual installation.
- ▷ Please refer to the actual circumstances for the number of screws and the position of screws.

2. When installation is finished, pull the mounting plate with hand to confirm whether it is fixed tightly. The force distribution for all screws should be uniform.
3. Open a piping hole with the diameter of  $\varnothing 55$  or  $\varnothing 70$  on the selected outlet pipe position. In order to drain smoothly, slant the piping hole on the wall slightly downward to the outdoor side with the gradient of 5-10°.



### NOTICE

- ▷ Pay attention to dust prevention and take relevant safety measures when opening the hole.

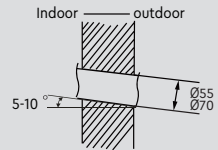

### Step 4:

#### Outlet pipe

1. The pipe can be led out in the direction of right, rear right, left or rear left.

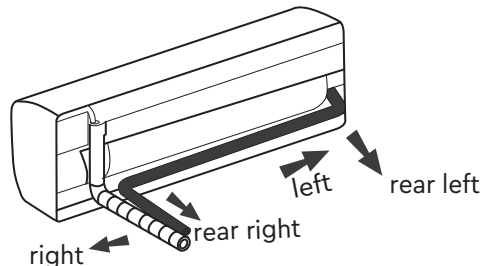

## INSTALLATION OF INDOOR UNIT

2. When select leading out the pipe from left or right, please cut off the corresponding hole on the bottom case.

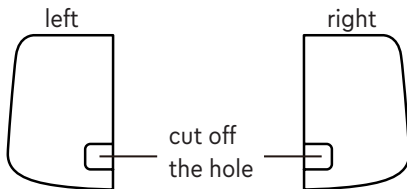

### Step 5:

#### Connect the pipe of indoor unit

1. Aim the pipe joint at the corresponding bellmouth.
2. Pretighten the union nut with hand.

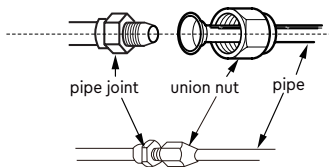

3. Adjust the torque force by referring to the following sheet. Place the open-end wrench on the pipe joint and place the torque wrench on the union nut. Tighten the union nut with torque wrench.

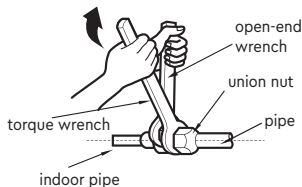

Hex nut diameter	Tightening torque (N.m)
1/4"	15~20
3/8"	30~40
1/2"	45~55
5/8"	60~65
3/4"	70~75

4. Wrap the indoor pipe and joint of connection pipe with insulating pipe, and then wrap it with tape.

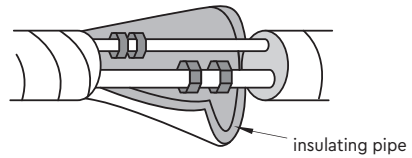

### Step 6:

#### Install drain hose

1. Connect the drain hose to the outlet pipe of indoor unit.

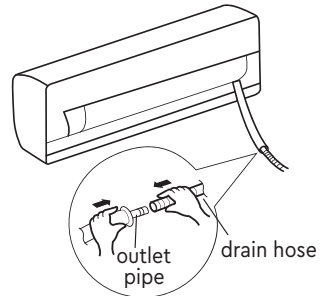

2. Bind the joint with tape.

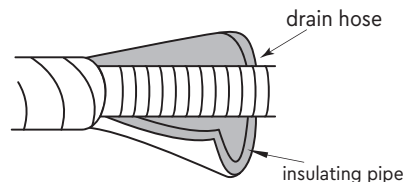
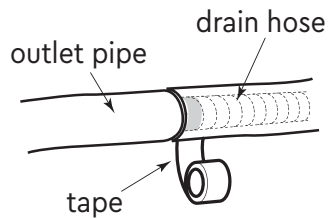

### NOTICE

- ▷ Add insulating pipe in the indoor drain hose in order to prevent condensation.
- ▷ The plastic expansion particles are not provided.

## INSTALLATION OF INDOOR UNIT

### Step 7:

#### Connect wire of indoor unit



#### NOTICE

- ▷ All wires of indoor unit and outdoor unit should be connected by a professional.
- ▷ If the length of power connection wire is insufficient, please contact the supplier for a new one. Avoid extending the wire by yourself.
- ▷ For the air conditioner with plug, the plug should be reachable after finishing installation.
- ▷ For the air conditioner without plug, an air switch must be installed in the line. The air switch should be all-pole parting and the contact parting distance should be more than 3mm.

1. Open the panel, remove the screw on the wiring cover and then take down the cover.

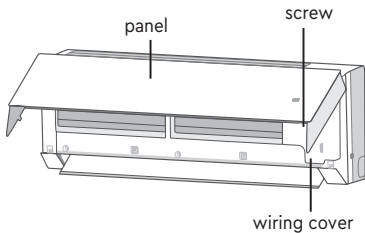

2. Make the power connection wire go through the cable-cross hole at the back of indoor unit and then pull it out from the front side.

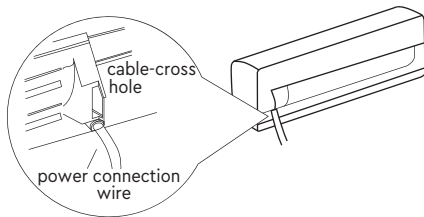

3. Remove the wire clip; connect the power connection wire to the wiring terminal according to the color; tighten the screw and then fix the power connection wire with wire clip.

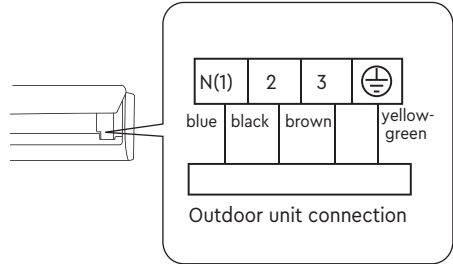

#### NOTICE

- ▷ The wiring board is for reference only, please refer to the actual one.
4. Put wiring cover back and then tighten the screw.
  5. Close the panel.

### Step 8:

#### Bind up pipe

1. Bind up the connection pipe, power cord and drain hose with the band.

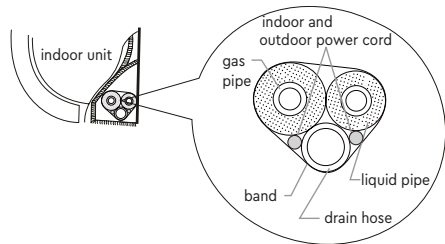

2. Reserve a certain length of drain hose and power cord for installation when binding them. When binding to a certain degree, separate the indoor power and then separate the drain hose.

## INSTALLATION OF INDOOR UNIT

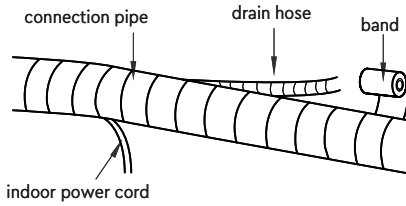

3. Bind them evenly
4. The liquid pipe and gas pipe should be bound separately at the end.



### NOTICE

- ▷ The power cord and control wire can't be crossed or winding.
- ▷ The drain hose should be bound at the bottom.

### Step 9:

#### Hang the indoor unit

1. Put the bound pipes in the wall pipe and then make them pass through the wall hole.
2. Hang the indoor unit on the wall-mounting frame.
3. Stuff the gap between pipes and wall hole with sealing gum.
4. Fix the wall pipe.
5. Check if the indoor unit is installed firmly and closed to the wall.

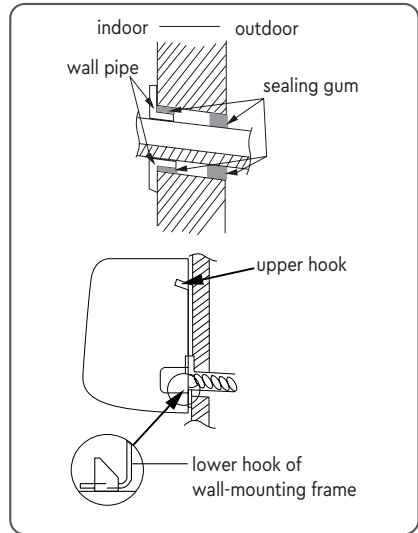

### NOTICE

- ▷ Do not bend the drain hose too excessively in order to prevent blocking.

## CLEAN AND MAINTENANCE



### WARNING



- ▷ Turn off the air conditioner and disconnect the power before cleaning the air conditioner to avoid electric shock.
- ▷ Do not wash the air conditioner with water to avoid electric shock.
- ▷ Do not use volatile liquid to clean the air conditioner.
- ▷ Do not use liquid or corrosive detergent to clean the appliance and do not splash water or other liquid onto it, otherwise, it may damage the plastic components, even cause electric shock.

### Clean surface of indoor unit

When the surface of indoor unit is dirty, it is recommended to use a soft dry cloth or wet cloth to wipe it.



### NOTICE

- ▷ Do not remove the panel when cleaning it.

### Clean filter

#### 1. Open panel

Pull out the panel to a certain angle as shown in the fig.

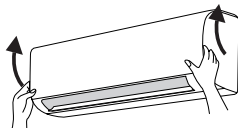

#### 2. Remove filter

Pull out the panel to a certain angle as shown in the fig.

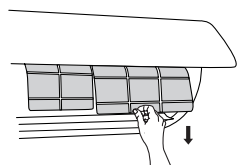

#### 3. Clean filter

Use dust catcher or water to clean the filter. When the filter is very dirty, use the water (below 45°C) to clean it, and then put it in a shady and cool place to dry.

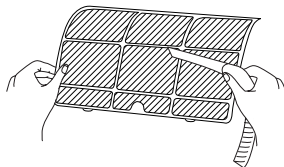

#### 4. Install filter

Install the filter and then close the panel cover tightly.

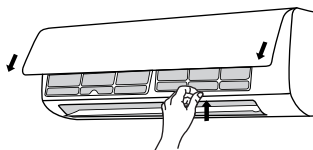

### WARNING



- ▷ The filter should be cleaned every three months. If there is much dust in the operation environment, clean frequency can be increased.
- ▷ After removing the filter, do not touch the fins to avoid injury.
- ▷ Do not use fire or hair dryer to dry the filter to avoid deformation or fire hazard.

## Clean surface of indoor unit



### NOTICE

#### Checking before use-season

1. Check whether air inlets and air outlets are blocked.
2. Check whether air switch, plug and socket are in good condition.
3. Check whether filter is clean.
4. Check whether mounting bracket for outdoor unit is damaged or corroded. If yes, please contact dealer.
5. Check whether drainage pipe is damaged

#### Checking after use-season

1. Disconnect power supply.
2. Clean filter and indoor unit's panel.
3. Check whether mounting bracket for outdoor unit is damaged or corroded. If yes, please contact dealer.

#### Notice for recovery

1. Many packing materials are recyclable materials. Please dispose them in appropriate recycling unit.
2. If you want to dispose the air conditioner, please contact local dealer or consultant service center for the correct disposal method.

## ERROR CODE

### Error Code

When air conditioner status is abnormal, temperature indicator on indoor unit will blink to display corresponding error code. Please refer to below list for identification of error code.

Error Code	Troubleshooting
<b>E1, E5, E6, E8, H6, U8</b>	It can be eliminated after restarting the unit. If not, please contact qualified professionals for service.
<b>C5, F0, F1, F2</b>	Please contact qualified professionals for service.



### NOTICE

If there're other error codes, please contact qualified professionals for service.

## CHECKED ITEMS BEFORE MAINTENANCE

### General phenomenon analysis

Please check below items before asking for maintenance. If the malfunction still can't be eliminated, please contact local dealer or qualified professionals.

## CHECKED ITEMS BEFORE MAINTENANCE

Phenomenon	Check items	Solution
Indoor unit can't receive remote controller's signal or remote controller has no action.	Whether it's interfered severely (such as static electricity, stable voltage?)	Pull out the plug. Reinsert the plug after about 3min, and then turn on the unit again.
	Whether remote controller is within the signal receiving range?	Signal receiving range is 8m.
	Whether there are obstacles?	Remove obstacles.
	Whether remote controller is pointing at the receiving window?	Select proper angle and point the remote controller at the receiving window on indoor unit.
	Is sensitivity of remote controller low; fuzzy display or no display?	Check the batteries. If the power of batteries is too low, please replace them.
	No display when operating remote controller?	Check whether remote controller appears to be damaged. If yes, replace it.
No air emitted from indoor unit	Fluorescent lamp in room?	Take the remote controller close to indoor unit. Turn off the fluorescent lamp and then try it again.
	Air inlet or air outlet of indoor unit is blocked?	Eliminate obstacles.
	Under heating mode, indoor temperature is reached to set temperature?	After reaching to set temperature, indoor unit will stop blowing out air.
Air conditioner can't operate	Heating mode is turned on just now?	In order to prevent blowing out cold air, indoor unit will be started after delaying for several minutes, which is a normal phenomenon.
	Power failure?	Wait until power recovery.
	Is plug loose?	Reinsert the plug.
	Air switch trips off or fuse is burnt out?	Ask professional to replace air switch or fuse.
	Wiring has malfunction?	Ask professional to replace it.
Mist is emitted from indoor unit's air outlet	Unit has restarted immediately after stopping operation?	Wait for 3 min, and then turn on the unit again.
	Whether the function setting for remote controller is correct?	Reset the function.
Odours are emitted	Indoor temperature and humidity is high?	Because indoor air is cooled rapidly. After a while, indoor temperature and humidity will be decrease and mist will disappear.
Set temperature can't be adjusted	Whether there's odour source, such as furniture and cigarette, etc.	Eliminate the odour source. Clean the filter.
Cooling (heating) effect is not good.	Your required temperature exceeds the set temperature range?	Set temperature range: 16 °C~30 °C. Set temperature range in HEAT mode: 8 °C ~30 °C .
	Voltage is too low?	Wait until the voltage resumes normal.
	Filter is dirty?	Clean the filter.
Air conditioner operates abnormally	Set temperature is in proper range?	Adjust temperature to proper range.
	Door and window are open?	Close door and window.
"Water flowing" noise	Whether there's interference, such as thunder, wireless devices, etc.	Disconnect power, put back power, and then turn on the unit again.
Cracking noise	Air conditioner is turned on or turned off just now?	The noise is the sound of refrigerant flowing inside the unit, which is a normal phenomenon.
Air guide louver can't be closed normally	Air conditioner is turned on or turned off just now?	This is the sound of friction caused by expansion and or contraction of panel or other parts due to the change of temperature.
	Whether the air guide louver has been adjusted?	Disconnect the power for 3s and then connect the power; if the problem still exits, disconnect the power, reinstall the air guide louver (install the upper air guide louver and then install the lower air guide louver) and then connect the power.



## WARNING



When below phenomenon occurs, please turn off air conditioner and disconnect power immediately, and then contact the dealer or qualified professionals for service.

- ▷ Power cord is overheating or damaged.
- ▷ There's abnormal sound during operation.

- ▷ Air switch trips off frequently.
- ▷ Air conditioner gives off burning smell.
- ▷ Indoor unit is leaking.

Do not repair or refit the air conditioner by yourself.

If the air conditioner operates under abnormal conditions, it may cause malfunction, electric shock or fire hazard.

## CONSTRUCTION OF THE INDOOR UNIT

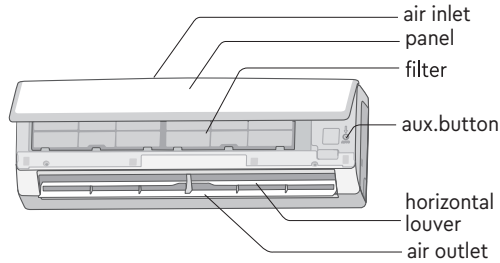

■ If remote controller is lost or damaged, please use aux. button to turn on or turn off the air conditioner. The operation in details is as below: As shown in the figure, open panel and press aux.button to turn off the air conditioner. When the air conditioner is turned on, it will operate under auto mode.

## DISPLAY

Heat mode			Red indicator
Cool mode			White indicator
Dry mode			Green indicator
			Orange indicator
Temp. indicator	26		
Power indicator			



## NOTICE

- ▷ This is the general introduction and the color of indicator is only for reference. Please refer to the actual display.
- ▷ Display content may be different from the actual. Please refer to the actual display.

## OPERATION AND INTRODUCTION OF REMOTE CONTROLLER



### BUTTONS ON REMOTE CONTROLLER





### INTRODUCTION FOR ICONS ON DISPLAY SCREEN

FAN	Set fan speed	
	Send signal	
	X-FAN button	
	Set temp.	
Temp. display type		Indoor ambient temp.
		Outdoor ambient temp.
Режим работы		Auto mode
		Cool mode
		Dry mode
		Fan mode
		Heat mode
	Set temperature	
	8°C heating function	
	Heat mode	
	Scavenging function	
	I Feel	
ONOFF	TIMER ON / TIMER OFF	
88:88	Set time	
WIFI	WiFi function	
	Light	
	Left & right swing	
	Up & down swing	
	Child lock	
	Turbo mode	
	Sleep mode	
	Quiet	
	Clock	

# INTRODUCTION FOR BUTTONS ON REMOTE CONTROLLER



## NOTICE

- ▷ This is a general use remote controller. It could be used for the air conditioner with multifunction. For the functions which the model doesn't have, if press the corresponding button on the remote controller, the unit will keep the original running status.
- ▷ After putting through the power, the air conditioner will give out a sound. Power indicator «  » is ON. After that, you can operate the air conditioner by using remote controller.
- ▷ Under on status, pressing the button on the remote controller, the signal icon «  » on the display of remote controller will blink once and the air conditioner will give out a «di» sound, which means the signal has been sent to the air conditioner.

## Button









Press this button to turn on the unit.  
Press this button again to turn off the unit.

## Button

Press this button to select your required operation mode.



- ▷ When selecting auto mode, air conditioner will operate automatically according to ex-factory setting. Set temperature can't be adjusted and will not be displayed as well. Press **FAN** button can adjust fan speed. Press  button can adjust fan blowing angle.

- ▷ After selecting cool mode, air conditioner will operate under cool mode. Press  or  button to adjust set temperature. Press **FAN** button to adjust fan speed. Press  button to adjust fan blowing angle.
- ▷ When selecting dry mode, the air conditioner operates at low speed under dry mode. Under dry mode, fan speed can't be adjusted. Press  button to adjust fan blowing angle.
- ▷ When selecting fan mode, the air conditioner will only blow fan, no cooling and no heating. All indicators are OFF. Press **FAN** button to adjust fan speed. Press  button to adjust fan blowing angle.
- ▷ When selecting heating mode, the air conditioner operates under heat mode. Press «» or «» button to adjust set temperature. Press **FAN** button to adjust fan speed. Press  button to adjust fan blowing angle. (Cooling only unit won't receive heating mode signal. If setting heat mode with remote controller, press  button can't start up the unit).







## NOTICE





- ▷ For preventing cold air, after starting up heat mode, indoor unit will delay 1~5 minutes to blow air (Actual delay time depends on indoor ambient temperature).
- ▷ Set temperature can be adjusted under AUTO mode.
- ▷ Set temperature range from remote controller: 16 ~ 30 °C (61 - 86 °F).
- ▷ Set temperature range from remote controller under HEAT mode: 8~30 °C (46-86 °F).
- ▷ This mode indicator is not available for some models.
- ▷ Cooling only unit won't receive heat mode signal. If setting heat mode with remote controller, press  button can't start up the unit.

FAN

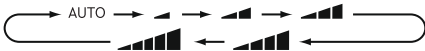

**Button**

This button is used for setting Fan Speed in the sequence that goes from AUTO, , , , , , then back to Auto.





 Low speed,  Low-Medium speed,  Medium speed,  Medium-High speed,  High speed

**NOTICE**

- ▷ It's low fan speed under dry mode.
- ▷ X-FAN function Hold fan speed button for 2s in cool or dry mode, the icon  is displayed and the indoor fan will continue operation for a few minutes in order to dry the indoor unit even though you have turned off the unit. After energization, X-FAN OFF is defaulted. X-FAN is not available in auto, fan or heat mode.
- ▷ This function indicates that moisture on evaporator of indoor unit will be blown after the unit is stopped to avoid mould.
- ▷ Having set X-FAN function on: After turning off the unit by pressing  button indoor fan will continue running for a few minutes. at low speed. In this period, Hold fan speed button for 2s to stop indoor fan directly.
- ▷ Having set X-FAN function off: After turning off the unit by pressing  button, the complete unit will be off directly.

TURBO

**Button**

Under COOL or HEAT mode, press this button to turn to quick COOL or quick HEAT mode.  icon is displayed on remote controller. Press this button again to exit turbo function and  icon will disappear.

If start this function, the unit will run at super-high fan speed to cool or heat quickly so that the ambient temperature approaches the preset temperature as soon as possible.

**Button**



Press «▲» or «▼» button once increase or decrease set temperature 1°C (°F). Holding «▲» or «▼» button, 2s later, set temperature on remote controller will change quickly. On releasing button after setting is finished, temperature indicator on indoor unit will change accordingly. (Temperature can't be adjusted under auto mode)

When setting T-ON, T-OFF or CLOCK, press «▲» or «▼» button to adjust time. (Refer to CLOCK, T-ON, T-OFF buttons)

**Button**

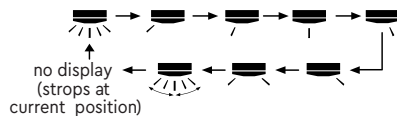
Press this button can select left & right swing angle. Fan blow angle can be selected circularly as below:

**NOTICE**

- ▷ Press this button continuously more than 2s, the main unit will swing back and forth from left to right, and then loosen the button, the unit will stop swinging and present position of guide louver will be kept immediately.
- ▷ Under swing left and right mode, when the status is switched from off to , if press this button again 2s later,  status will switch to off status directly; if press this button again within 2s, the change of swing status will also depend on the circulation sequence stated above.
- ▷ This function only applicable for some models.

## Button

Press this button can select up & down swing angle. Fan blow angle can be selected circularly as below:

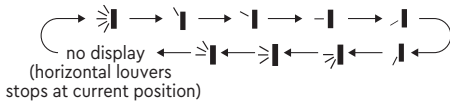

- ▷ When selecting , air conditioner is blowing fan automatically. Horizontal louver will automatically swing up & down at maximum angle.
- ▷ When selecting , a air conditioner is blowing fan at fixed position. Horizontal louver will stop at the fixed position.
- ▷ When selecting , air conditioner is blowing fan at fixed angle.
- ▷ Hold « » button above 2s to set your required swing angle. When reaching your required angle, release the button.



## NOTICE

- ▷ may not be available. When air conditioner receives this signal, the air conditioner will blow fan automatically.
- ▷ Press this button continuously more than 2s, the main unit will swing back and forth from up to down, and then loosen the button, the unit will stop swinging and present position of guide louver will be kept immediately.
- ▷ Under swing up and down mode, when the status is switched from off to , if press this button again 2s later, status will switch to off status directly; if press this button again within 2s, the change of swing status will also depend on the circulation sequence stated above.

## SLEEP Button

Press this button, can select Sleep 1 ( ), Sleep 2 ( ), Sleep 3 ( ) and cancel the Sleep, circulate between these, after electrified, Sleep Cancel is defaulted.

- ▷ Sleep 1 is Sleep mode 1, in Cool modes; sleep status after run for one hour, the main unit setting temperature will increase 1 , two hours, setting temperature increased 2 , then the unit will run at this setting temperature; In Heat mode: sleep status after run for one hour, the setting temperature will decrease 1 , two hours, setting temperature will decrease 2 , then the unit will run at this setting temperature.
- ▷ Sleep 2 is sleep mode 2, that is air conditioner will run according to the presetting a group of sleep temperature curve.
- ▷ Sleep 3 - the sleep curve setting under Sleep mode by DIY;
  1. Under Sleep 3 mode, press "Turbo" button for a long time, remote controller enters into user individuation sleep setting status, at this time, the time of remote controller will display "1hour ", the setting temperature "88" will display the corresponding temperature of last setting sleep curve and blink (The first entering will display according to the initial curve setting value of original factory);
  2. Adjust « » and « » button, could change the corresponding setting temperature, after adjusted, press "Turbo" button for confirmation;
  3. At this time, 1hour will be automatically increased at the timer position on the remote control, (that are «2hours» or «3hours» or «8 hours«), the place of setting temperature «88 « will display the corresponding temperature of last setting sleep curve and blink;
  4. Repeat the above step (2)~(3) operation, until 8 hours temperature setting finished, sleep,curve setting finished, at this time, the remote controller will resume the original timer display; temperature display will resume to original setting temperature.

- ▷ Sleep 3-the sleep curve setting under Sleep mode by DIY could be inquired: The user could accord to sleep curve setting method to inquire the presetting sleep curve, enter into user individuation sleep setting status, but do not change the temperature, press "Turbo" button directly for confirmation.



## NOTICE

- ▷ In the above presetting or enquiry procedure, if continuously within 10s, there is no button pressed, the sleep curve setting within 10s, there is no button pressed, the sleep curve setting status will be automatically quit and resume to display the original displaying. In the presetting or enquiry procedure, press «ON/OFF» button, «Mode» button, «Sleep» button, the sleep curve setting or enquiry status will quit similarly.

I FEEL

## Button

Press «Health» and « + » buttons Press this button to start I FEEL function and « « will be displayed on the remote controller. After this function is set, the remote controller will send

the detected ambient temperature to the controller

and the unit will automatically adjust the indoorPlease put the remote controller near user when this function is set. Do not put the remote controller near the object of high temperature or low temperature in order to avoid detecting inaccurate ambient temperature.When I FEEL function is turned on, the remote controller should be put within the area where indoor unit can receive the signal sent by the remote controller.

TIMER ON

TIMER OFF

## Button

### TIMER ON Button

«TIMER ON» button can set the time for timer on. After pressing this button, ⌚ icon disappears and the word «ON» on remote controller blinks. Press «▲» or «▼» button to adjust TIMER ON setting. After each pressing «▲» or «▼» button, TIMER ON setting will increase or decrease 1min. Hold «▲» or «▼» button, 2s later, the time will change quickly until reaching your required time.

Press «TIMER ON» to confirm it. The word «ON» will stop blinking. ⌚ icon resumes displaying. Cancel TIMER ON: Under the condition that TIMER ON is started up, press «TIMER ON» button to cancel it.

### TIMER OFF Button

«TIMER OFF» button can set the time for timer off. After pressing this button, ⌚ icon disappears and the word «OFF» on remote controller blinks. Press «▲» or «▼» button to adjust TIMER OFF setting. After each pressing «▲» or «▼» button, TIMER OFF setting will increase or decrease 1min. Hold «▲» or «▼» button, 2s later, the time will change quickly until reaching your required time.



Press «TIMER OFF» word «OFF» will stop blinking. ⌚ icon resumes displaying. Cancel TIMER OFF: Under the condition that TIMER OFF is started up, press «TIMER OFF» button to cancel it.



## NOTICE

- ▷ Under on and off status, you can set TIMER OFF or TIMER ON simultaneously.
- ▷ Before setting TIMER ON or TIMER OFF, please adjust the clock time.
- ▷ After starting up TIMER ON or TIMER OFF, set the constant circulating valid. After that, air conditioner will be turned on or turned off according to setting time. ⏻ button has no effect on setting. If you don't need this function, please use remote controller to cancel it.

### Button



Press this button to set clock time.  icon on remote controller will blink. Press «▲» or «▼» button within 5s to set clock time. Each pressing of «▲» or «▼» button, clock time will increase or decrease 1 min. If hold «▲» or «▼» button, 2s later, time will change quickly. Release this button when reaching your required time. Press «CLOCK» button to confirm the time.  icon stops blinking.



### NOTICE

- ▷ Clock time adopts 24-hour mode.
- ▷ The interval between two operation can't exceeds 5s. Otherwise, remote controller will quit setting status. Operation for TTIMER ON/TIMER OFF is the same.

### Button

Press this button, the Quiet status is under the Auto button Quiet mode (display «» and «AUTO» signal ) and Quiet mode (display «» signal) and Quiet OFF there is no signal of «» displayed). After powered on, the Quiet OFF is defaulted.



### NOTICE

- ▷ The quiet function is only available for some models. The
- ▷ Quiet function can be set up in all modes; Under the Quiet mode, the fan speed is not available.
- ▷ When quiet function is selected:
  - Under cooling mode: indoor fan operates at notch 4 speed. 10 minutes later or when indoor ambient temperature  $\leq 28^{\circ}\text{C}$ , indoor fan will operate at notch 2 speed or quiet mode according to the comparison between indoor ambient temperature and set temperature.

- Under heating mode: indoor fan operates at notch 3 speed or quiet mode according to the comparison between indoor ambient temperature and set temperature.
- Under dry, fan mode: indoor fan operates at quiet mode. Under auto mode: the indoor fan operates at the auto quiet mode according to actual cooling, heating or fan mode.



### Button

Press «WIFI» button to turn on WiFi function, **WiFi** icon will be displayed on the remote controller;



Hold «WIFI» button for 5s to turn off WiFi function and **WiFi** icon will disappear.

Under off status, press «MODE» and «WIFI» buttons simultaneously for 1s, WiFi module will restore factory settings.

### Button

Press this button to turn off display light on indoor unit. «» icon on remote controller disappears. Press this button again to turn on display light. «» icon is displayed.

### Button



Press this button to turn on or turn off the health and scavenging functions in operation status. Press this button for the first time to start scavenging function; LCD displays . Press the button for the second time to start health and scavenging functions simultaneously; LCD displays  and . Press this button for the third time to quit health and scavenging functions simultaneously.

Press the button for the fourth time to start health function; LCD display . Press this button again to repeat the operation above.

## TEMP Button

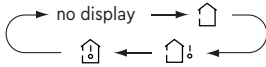
By pressing this button, you can see indoor set temperature, indoor ambient temperature or outdoor ambient temperature on indoor unit's display. The setting on remote controller is selected circularly as below:



- ▷ When selecting  or no display with remote controller, temperature indicator on indoor unit displays set temperature.
- ▷ When selecting  with remote controller, temperature indicator on indoor unit displays indoor ambient temperature.
- ▷ When selecting  with remote controller, temperature indicator on indoor unit displays outdoor ambient temperature.



## NOTICE

- Outdoor temperature display is not available for some models. At that time, indoor unit receives  signal, while it displays indoor set temperature.
- It's defaulted to display set temperature when turning on the unit. There is no display in the remote controller.
- Only for the models whose indoor unit has dual-8 display.
- When selecting displaying of indoor or outdoor ambient temperature, indoor temperature indicator displays corresponding temperature and automatically turn to display set temperature after three or five seconds.

## FUNCTION INTRODUCTION FOR COMBINATION BUTTONS

### Energy-saving function

Under cooling mode, press «TEMP» and «CLOCK» buttons simultaneously to start up or turn off energy-saving function. When energy-saving function is started up, «SE» will be shown on remote controller, and air conditioner will adjust the set temperature automatically according to ex-factory setting to reach to the best energy-saving effect.



Press «TEMP» and «CLOCK» buttons simultaneously again to exit energy-saving function.



#### NOTICE

- ▷ Under energy-saving function, fan speed is defaulted at auto speed and it can't be adjusted.
- ▷ Under energy-saving function, set temperature can't be adjusted. Press «TURBO» button and the remote controller won't send signal.
- ▷ Sleep function and energy-saving function can't operate at the same time. If energy-saving function has been set under cooling mode, press «SLEEP» button will cancel energy-saving function. If sleep function has been set under cooling mode, start up the energy-saving function will cancel sleep function.

### Child lock function

Press «▲» and «▼» simultaneously to turn on or turn off child lock function. When child lock function is on, «» icon is displayed on remote controller. If you operate the remote controller, the «» icon will blink three times without sending signal to the unit.

### 8°C heating function

Under heating mode, press «TEMP» and «CLOCK» buttons simultaneously to start up or turn off 8°C heating function. When this function is started up, «» and «8°C» will be shown on remote controller, and the air conditioner keep the heating status at 8°C. Press «TEMP» and «CLOCK» buttons simultaneously again to exit 8°C heating function.



#### NOTICE

- ▷ Under 8°C heating function, fan speed is defaulted at auto speed and it can't be adjusted.
- ▷ Under 8°C heating function, set temperature can't be adjusted. Press «TURBO» button and the remote controller won't send signal.
- ▷ Sleep function and 8°C heating function can't operate at the same time. If 8°C heating function has been set under cooling mode, press «SLEEP» button will cancel 8°C heating function. If sleep function has been set under cooling mode, start up the 8°C heating function will cancel sleep function.
- ▷ Under °F temperature display, the remote controller will display 46°F heating.

### Auto clean function

Under unit off status, hold «MODE» and «FAN» buttons simultaneously for 5s to turn on or turn off the auto clean function. When the auto clean function is turned on, indoor unit displays «CL». During the auto clean process of evaporator, the unit will perform fast cooling or fast heating. There may be some noise, which is the sound of flowing liquid or thermal expansion or cold shrinkage. The air conditioner may blow cool or warm air, which is a normal phenomenon. During cleaning process, please make sure the room is well ventilated to avoid affecting the comfort.



## NOTICE

- ▷ This function is only available for some models.
- ▷ The auto clean function can only work under normal ambient temperature. If the room is dusty, clean it once a month; if not, clean it once every three months. After the auto clean function is turned on, you can leave the room. When auto clean is finished, the air conditioner will enter standby status.

## Temperature display switchover function

Under OFF status, press «▼» and «MODE» buttons simultaneously to switch temperature display between °C and °F.

## Multi timer function

### • THREE TIMERS

Press uninterruptedly «LIGHT» button 6 times in 5 seconds thus we enter the «Multi Timer» mode as well as three-minute-counting-down stars. If three couples of times commands are valid and well-received in 3 minutes, the «Multi Timer» will be activated along with the success sound of four buzzing, and the former «Multi Timer» settings will be replaced. If not, then «Multi Timer» mode exits along with the failure sound of six buzzing, and the former «Multi Timer» settings still remain effective.

### • TWO TIMERS

Press uninterruptedly «LIGHT» button 4 times in 5 seconds thus we enter the «Multi Timer» mode as well as two-minute-counting-down stars. If two couples of times commands are valid and well-received in 2 minutes, the «Multi Timer» will be activated along with the success sound of four buzzing, and the former «Multi Timer» settings will be replaced. If not, then «Multi Timer» mode exits along with the failure sound of six buzzing, and the former «Multi Timer» settings still remain effective

### • TIMER CANCELLATION.

Press uninterruptedly «LIGHT» button 8 times in 5 seconds all the «Multi Timer» settings will be eased.

### • INVALID OPERATION

1. When the three-minute-counting-down in THREE TIMERS, or the two-minute-counting-down in TWO TIMERS is due.
2. TIMER commands are not on-off coupled.
3. TIMER spans overlap each other.
4. TIMER span is shorter than 4 minutes.

### • INTERACTIVE BUZZING

1. After successfully entering the «Multi Timer» mode, one buzzing will be heard to prompt that now you can use the «TIMER ON» and «TIMER OFF» buttons to do the TIMER 1.
2. After successful setting of TIMER 1, two buzzing will be heard to prompt that now you can use the «TIMER ON» and «TIMER OFF» buttons to do the TIMER 2.
3. After successful setting of TIMER 2, three buzzing will be heard to prompt that now you can use the «TIMER ON» and «TIMER OFF» buttons to do the TIMER 3.
4. After successful setting of TIMER 3 in THREE TIMERS, or after successful setting of TIMER 2 in TWO TIMERS, four buzzing will be heard to congratulate you that «Multi Timer» is done.
5. If there are any invalid operations, or cancellation commands, six buzzing will be heard.



## NOTICE

1. Memory function does not cover the «Multi Timer».
  2. The time calibration of remote controller is not effective after setting «Multi Timer».
  3. «Multi Timer» function is prioritized over the original «TIMER ON» and «TIMER OFF» function.
  4. «Multi Timer» function will not be useful any remote controller which does not have LIGHT button.
  5. «Multi Timer» function can be set only in unit off status.
- ▷ This function is only available for some models.

## Replacement of batteries in remote controller

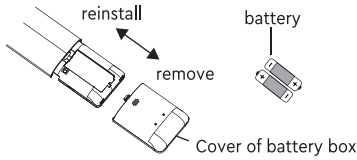

1. Press the back side of remote controller marked with « ≡ », as shown in the fig, and then push out the cover of battery box along the arrow direction.
2. Replace two 7# (AAA 1.5V) dry batteries, and make sure the position of «+» polar and «-» polar are correct.
3. Reinstall the cover of battery box.



### NOTICE

- ▷ During operation, point the remote control signal sender at the receiving window on indoor unit.
- ▷ The distance between signal sender and receiving window should be no more than 8m, and there should be no obstacles between them.
- ▷ Signal may be interfered easily in the room where there is fluorescent lamp or wireless telephone; remote controller should be close to indoor unit during operation.
- ▷ Replace new batteries of the same model when replacement is required.
- ▷ When you don't use remote controller for a long time, please take out the batteries.
- ▷ If the display on remote controller is fuzzy or there's no display, please replace batteries.

## CONSTRUCTION OF THE OUTDOOR UNIT

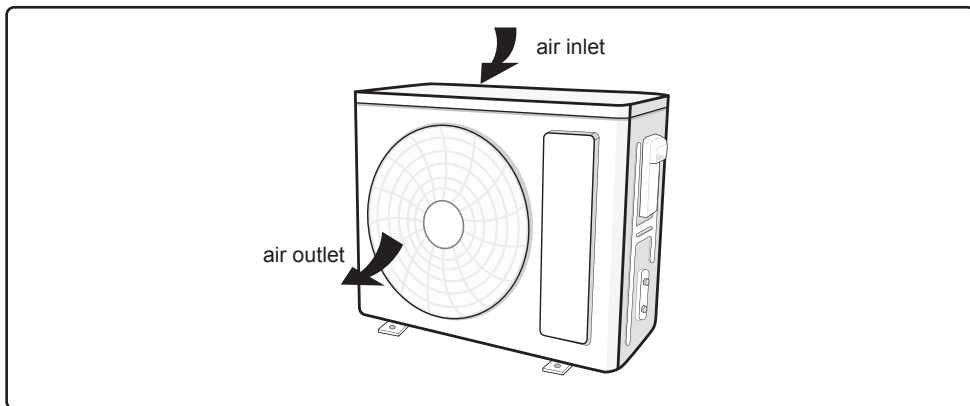

### NOTICE

▷ Actual product may be different from above graphics, please refer to actual product.

## INSTALLATION NOTICE

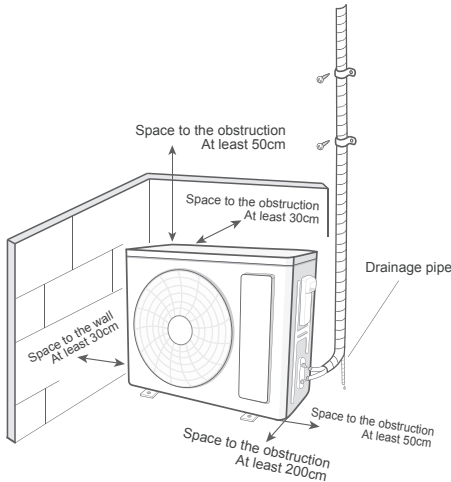

### Safety precautions for installing and relocating the unit

To ensure safety, please be mindful of the following precautions.

#### ! CAUTION !

- ▷ **When installing or relocating the unit, be sure to keep the refrigerant circuit free from air or substances other than the specified refrigerant.**

Any presence of air or other foreign substance in the refrigerant circuit will cause system pressure rise or compressor rupture, resulting in injury.

- ▷ **When in stalling or moving this unit, do not charge the refrigerant which is not comply with that on the nameplate or unqualified refrigerant.**

Otherwise, it may cause abnormal operation, wrong action, mechanical malfunction or even serious safety accident.

- ▷ **When refrigerant needs to be recovered during relocating or repairing the unit, be sure that the unit is running in cooling**

#### ! CAUTION !

mode. Then, fully close the valve at high pressure side (liquid valve). About 30-40 seconds later, fully close the valve at low pressure side (gas valve), immediately stop the unit and disconnect power. Please note that the time for refrigerant recovery should not exceed 1 minute.

If refrigerant recovery takes too much time, air may be sucked in and cause pressure rise or compressor rupture, resulting in injury.

- ▷ **During refrigerant recovery, make sure that liquid valve and gas valve are fully closed and power is disconnected before detaching the connection pipe.**

If compressor starts running when stop valve is open and connection pipe is not yet connected, air will be sucked in and cause pressure rise or compressor rupture, resulting in injury.

- ▷ **When installing the unit, make sure that connection pipe is securely connected before the compressor starts running.**

If compressor starts running when stop valve is open and connection pipe is not yet connected, air will be sucked in and cause pressure rise or compressor rupture, resulting in injury.

- ▷ **Prohibit installing the unit at the place where there may be leaked corrosive gas or flammable gas.**

If there is leaked gas around the unit, it may cause explosion and other accidents.

- ▷ **Do not use extension cords for electrical connections. If the electric wire is not long enough, please contact a local service center authorized and ask for a proper electric wire.**

Poor connections may lead to electric shock or fire.

- ▷ **Use the specified types of wires for electrical connections between the indoor and outdoor units. Firmly clamp the wires so that their terminals receive no external stresses.**

Electric wires with insufficient capacity, wrong wire connections and insecure wire terminals may cause electric shock or fire.

## INSTALLATION NOTICE

### Tools for installation

1. Level meter
2. Screw driver
3. Impact drill
4. Drill head
5. Open-end wrench
6. Pipe cutter
7. Leakage detector
8. Universal meter
9. Inner hexagon spanner
10. Measuring tape
11. Pipe expander
12. Torque wrench
13. Vacuum pump
14. Pressure meter



### NOTICE

- ▷ Please contact the local agent for installation.
- ▷ Don't use unqualified power cold.

## SELECTION OF INSTALLATION LOCATION

### Basic requirement

Installing the unit in the following places may cause malfunction. If it is unavoidable, please consult the local dealer:

1. The place with strong heat sources, vapors, flammable or explosive gas, or volatile objects spread in the air.
2. The place with high-frequency devices (such as welding machine, medical equipment).
3. The place near coast area.
4. The place with oil or fumes in the air.
5. The place with sulfureted gas.
6. Other places with special circumstances.
7. The appliance shall not be installed in the laundry.
8. It's not allowed to be installed on the unstable or motive base structure (such as truck) or in the corrosive environment (such as chemical factory).

### Outdoor unit

1. Select a location where the noise and outflow air emitted by the outdoor unit will not affect neighborhood.
2. The location should be well ventilated and dry, in which the outdoor unit won't be exposed directly to sunlight or strong wind.
3. The location should be able to withstand the weight of outdoor unit.
4. Make sure that the installation follows the requirement of installation dimension diagram.
5. Select a location which is out of reach for children and far away from animals or plants. If it is unavoidable, please add the fence for safety purpose.

## INSTALLATION NOTICE

### Safety precaution

1. Must follow the electric safety regulations when installing the unit.
2. According to the local safety regulations, use qualified power supply circuit and air switch.
3. Make sure the power supply matches with the requirement of air conditioner. Unstable power supply or incorrect wiring or malfunction. Please install proper power supply cables before using the air conditioner.
4. Properly connect the live wire, neutral wire and grounding wire of power socket.
5. Be sure to cut off the power supply before proceeding any work related to electricity and safety.
6. Do not put through the power before finishing installation.
7. If the supply cord is damaged, it must be replaced by the manufacturer, its service agent or similarly qualified persons in order to avoid a hazard.
8. The temperature of refrigerant circuit will be high, please keep the interconnection cable away from the copper tube.
9. The appliance shall be installed in accordance with national wiring regulations.

### Grounding requirement

1. The air conditioner is the first class electric appliance. It must be properly grounded with specialized grounding device by a professional. Please make sure it is always grounded effectively, otherwise it may cause electric shock.
2. The yellow-green wire in air conditioner is grounding wire, which can't be used for other purposes.
3. The grounding resistance should comply with national electric safety regulations.
4. The appliance must be positioned so that the plug is accessible.
5. An all-pole disconnection switch having a contact separation of at least 3mm in all poles should be connected in fixed wiring.

### Air switch capacity

Including an air switch with suitable capacity, please note the following table. Air switch should be included magnet buckle and heating buckle function, it can protect the circuits short and overload.

(Caution: please do not use the fuse only for protect the circuit)

Air-conditioner	Air switch capacity
09K, 12K	10A
18K	16A
24K	25A

## INSTALLATION OF OUTDOOR UNIT

### Step 1: Fix the support of outdoor unit

(select it according to the actual installation situation)

1. Select installation location according to the house structure.
2. Fix the support of outdoor unit on the selected location with expansion screws.

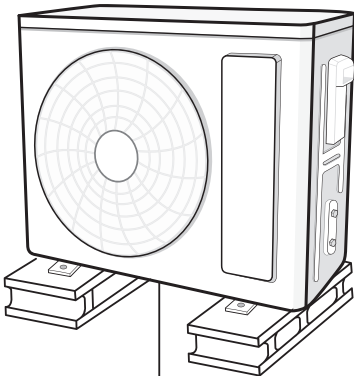

at least 3cm above the floor



### NOTICE

- ▷ Take sufficient protective measures when installing the outdoor unit.
- ▷ Make sure the support can withstand at least four times of the unit weight.
- ▷ The outdoor unit should be installed at least 3cm above the floor in order to install drain joint. (for the model with heating tube, the installation height should be no less than 20cm.)
- ▷ For the unit with cooling capacity of 2300 W ~ 5000 W, 6 expansion screws are needed; for the unit with cooling capacity of 6000 W ~ 8000 W, 8 expansion screws are needed; for the unit with cooling capacity of 10000 W ~ 16000 W, 10 expansion screws are needed.

### Step 2:

#### Install drain joint

(only for some models)

1. Connect the outdoor drain joint into the hole on the chassis, as shown in the picture below.
2. Connect the drain hose into the drain vent.



### NOTICE

- ▷ As for the shape of drainage joint, please refer to the current product. Do not install the drainage joint in the severe cold area. Otherwise, it will be frosted and then cause malfunction.

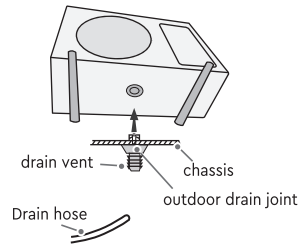

### Step 3:

#### Fix outdoor unit

1. Place the outdoor unit on the support.
2. Fix the foot holes of outdoor unit with bolts.

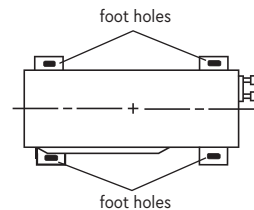

## INSTALLATION OF OUTDOOR UNIT

### Step 4:

#### Connect indoor and outdoor pipes

1. Remove the screw on the right handle of outdoor unit and then remove the handle.

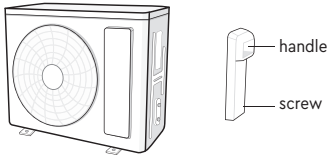

2. Remove the screw cap of valve and aim the pipe joint at the bellmouth of pipe.

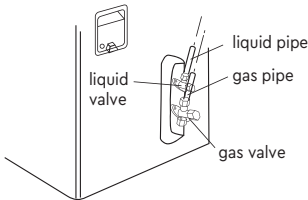

3. Pretighten the union nut with hand.

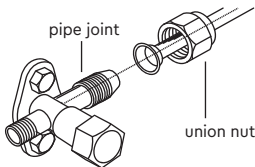

4. Tighten the union nut with torque wrench by referring to the sheet below.

Hex nut diameter	Tightening torque (N m)
1/4"	15~20
3/8"	30~40
1/2"	45~55
5/8"	60~65
3/4"	70~75

### Step 5:

#### Connect outdoor electric wire

1. Remove the wire clip; connect the power connection wire and signal control wire (only for cooling and heating unit) to the wiring terminal according to the color; fix them with screws.

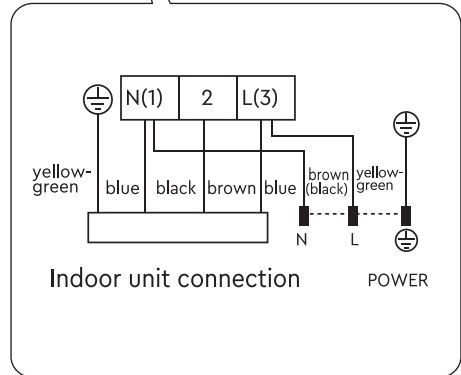
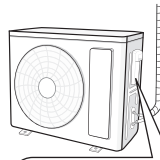

#### NOTICE

- ▷ The wiring board is for reference only, please refer to the actual one.
2. Fix the power connection wire and signal control wire with wire clip (only for cooling and heating unit).



#### NOTICE

- ▷ After tighten the screw, pull the power cord slightly to check if it is firm.
- ▷ Never cut the power connection wire to prolong or shorten the distance.

## INSTALLATION OF OUTDOOR UNIT

### Step 6:

#### Neaten the pipes

1. The pipes should be placed along the wall, bent reasonably and hidden possibly. Min. semidiameter of bending the pipe is 10cm.
2. If the outdoor unit is higher than the wall hole, you must set a U-shaped curve in the pipe before pipe goes into the room, in order to prevent rain from getting into the room.

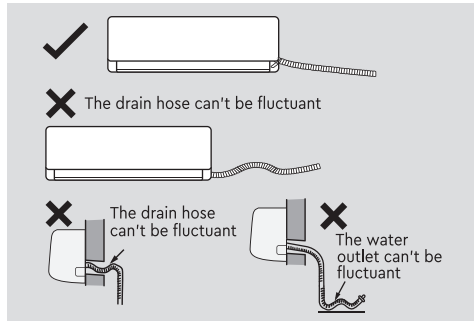
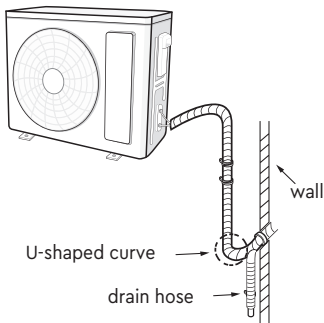

### NOTICE

- ▷ The through-wall height of drain hose should not be higher than the outlet pipe hole of indoor unit.

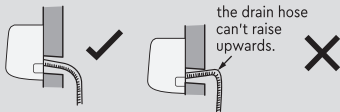

- ▷ The water outlet can't be placed in water in order to drain smoothly.

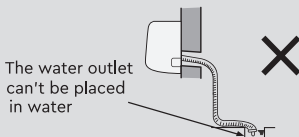

- ▷ Slant the drain hose slightly downwards. The drain hose can't be curved, raised and fluctuant, etc.

## TEST AND OPERATION

### Use vacuum pump

1. Remove the valve caps on the liquid valve and gas valve and the nut of refrigerant charging vent.
2. Connect the charging hose of piezometer to the refrigerant charging vent of gas valve and then connect the other charging hose to the vacuum pump.
3. Open the piezometer completely and operate for 10–15 min to check if the pressure of piezo- meter remains in -0.1 MPa.
4. Close the vacuum pump and maintain this sta- tus for 1–2 min to check if the pressure of piezometer remains in -0.1 MPa. If the pressure decreases, there may be leakage.
5. Remove the piezometer, open the valve core of liquid valve and gas valve completely with inner hexagon spanner.
6. Tighten the screw caps of valves and refrigerant charging vent.
7. Reinstall the handle.

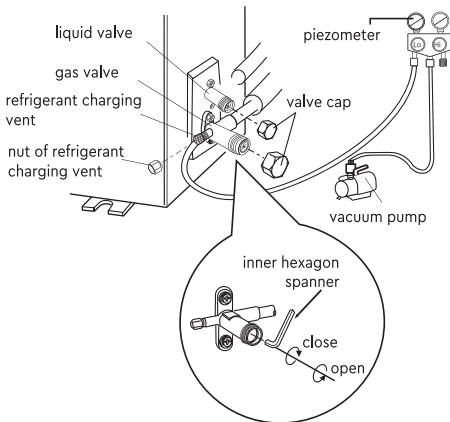

### Leakage detection

1. **With leakage detector:** Check if there is leakage with leakage detector.
2. **With soap water:** If leakage detector is not available, please use soap water for leakage detection. Apply soap water at the suspected position and keep the soap water for more than 3min. If there are air bubbles coming out of this position, there's a leakage.

### Check after installation

- ▷ Check according to the following requirement after finishing installation.

Items to be checked	Possible malfunction
Has the unit been installed firmly?	The unit may drop, shake or emit noise.
Have you done the refrigerant leakage test?	It may cause insufficient cooling (heating) capacity.
Is heat insulation of pipeline sufficient?	It may cause condensation and water dripping.
Is water drained well?	It may cause condensation and water dripping.
Is the voltage of power supply according to the voltage marked on the nameplate?	It may cause malfunction or damage the parts.
Is electric wiring and pipeline installed correctly?	It may cause malfunction or damage the parts.
Is the unit grounded securely?	It may cause electric leakage.
Does the power cord follow the specification?	It may cause malfunction or damage the parts.
Is there any obstruction in the air inlet and outlet?	It may cause insufficient cooling(heating) capacity.
The dust and sundries caused during installation are removed?	It may cause malfunction or damage the parts.
The gas valve and liquid valve of connection pipe are open completely?	It may cause insufficient cooling (heating) capacity.
Is the inlet and outlet of piping hole been covered?	It may cause insufficient cooling (heating) capacity or waste electricity.

### Test operation

1. **Preparation of test operation**

▷ The client approves the air conditioner.

▷ Specify the important notes for air conditioner to the client.
2. **Method of test operation**

▷ Put through the power, press ON/OFF button on the remote controller to start operation.

▷ Press MODE button to select AUTO, COOL, DRY, FAN and HEAT to check whether the operation is normal or not.

▷ If the ambient temperature is lower than 16°C, the air conditioner can't start cooling.

## CONFIGURATION OF CONNECTION PIPE

- Standard length of connection pipe: 5 m, 7.5 m, 8 m.
- Min. length of connection pipe.  
For the unit with standard connection pipe of 5 m, there is no limitation for the min length of connection pipe. For the unit with standard connection pipe of 7.5 m and 8 m, the min length of connection pipe is 3 m.
- Max. length of connection pipe is shown as below.

### Max. length of connection pipe

Cooling capacity	Max. length of connection pipe (m)
5000 Btu/h (1465 W)	15
7000 Btu/h (2051 W)	15
9000 Btu/h (2637 W)	15
12000 Btu/h (3516 W)	20
18000 Btu/h (5274 W)	25
24000 Btu/h (7032 W)	25
28000 Btu/h (8204 W)	30
36000 Btu/h (10548 W)	30
42000 Btu/h (12306 W)	30
48000 Btu/h (14064 W)	30

- The calculation method of additional refrigerant oil and refrigerant charging amount after prolonging connection pipe  
After the length of connection pipe is prolonged for 10m at the basis of standard length, you should add 5ml of refrigerant oil for each additional 5m of connection pipe. The calculation method of additional refrigerant charging amount (on the basis of liquid pipe):

(1) Additional refrigerant charging amount = prolonged length of liquid pipe × additional refrigerant charging amount per meter

(2) Basing on the length of standard pipe, add refrigerant according to the requirement as shown in the table. The additional refrigerant charging amount per meter is different according to the diameter of liquid pipe. See Sheet .

### Additional refrigerant charging amount for R32

Piping size	Outdoor unit throttle		Indoor unit throttle	Gas pipe	Liquid pipe
	Cooling and heating (g / m)	Cooling only (g / m)			
3/8" or 1/2"	16	12	16	3/8" or 1/2"	1/4"
5/8" or 3/4"	40	12	40	5/8" or 3/4"	1/4" or 3/8"
3/4" or 7/8"	96	24	80	3/4" or 7/8"	1/2"
1" or 1 1/4"	96	48	136	1" or 1 1/4"	5/8"
-	200	200	200	-	3/4"
-	280	280	280	-	7/8"



### NOTICE

The additional refrigerant charging amount in Sheet is recommended value, not compulsory.

## PIPE EXPANDING METHOD



### NOTICE

Improper pipe expanding is the main cause of refrigerant leakage. Please expand the pipe according to the following steps:

### A: Cut the pipe

- ▷ Confirm the pipe length according to the distance of indoor unit and outdoor unit.
- ▷ Cut the required pipe with pipe cutter.

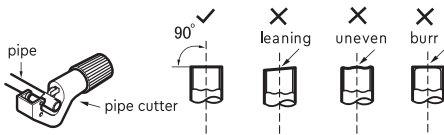

### B: Remove the burrs

- ▷ Remove the burrs with shaper and prevent the burrs from getting into the pipe.

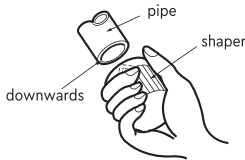

### C: Put on suitable insulating pipe

### D: Put on the union nut

- ▷ Remove the union nut on the indoor connection pipe and outdoor valve; install the union nut on the pipe.

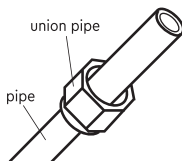

### E: Expand the port

- ▷ Expand the port with expander.

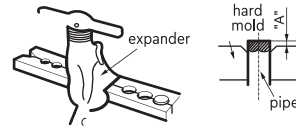

### NOTICE

«A» is different according to the diameter, please refer to the sheet below:

Outer diameter (mm)	A (mm)	
	max	min
Ø6 - 6,35 (1/4")	1,3	0,7
Ø9 - 9,52 (3/8")	1,6	1,0
Ø12 - 12,7 (1/2")	1,8	1,0
Ø15,8 - 16 (5/8")	2,4	2,2

### F: Inspection

- ▷ Check the quality of expanding port. If there is any blemish, expand the port again according to the steps above.

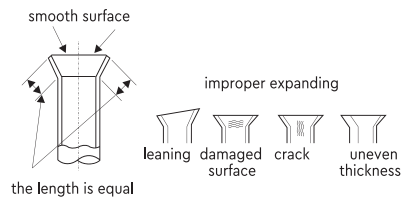

## SPECIALIST'S MANUAL

### The following checks shall be applied to installations using flammable refrigerants:

- ▷ the charge size is in accordance with the room size within which the refrigerant containing parts are installed;
- ▷ the ventilation machinery and outlets are operating adequately and are not obstructed;
- ▷ if an indirect refrigerating circuit is being used, the secondary circuit shall be checked for the presence of refrigerant;
- ▷ marking to the equipment continues to be visible and legible. Markings and signs that are illegible shall be corrected;
- ▷ refrigeration pipe or components are installed in a position where they are unlikely to be exposed to any substance which may corrode refrigerant containing components, unless the components are constructed of materials which are inherently resistant to being corroded or are suitably protected against being so corroded.

**Repair and maintenance to electrical components shall include initial safety checks and component inspection procedures. If a fault exists that could compromise safety, then no electrical supply shall be connected to the circuit until it is satisfactorily dealt with. If the fault cannot be corrected immediately but it is necessary to continue operation, an adequate temporary solution shall be used.**

This shall be reported to the owner of the equipment so all parties are advised.

#### Initial safety checks shall include:

- ▷ that capacitors are discharged: this shall be done in a safe manner to avoid possibility of sparking;
- ▷ that no live electrical components and wiring are exposed while charging, recovering or purging the system;
- ▷ that there is continuity of earth bonding.

#### Checking for presence of refrigerant

The area shall be checked with an appropriate refrigerant detector prior to and during work, to ensure the technician is aware of potentially toxic or flammable atmospheres. Ensure that the leak detection equipment being used is suitable for use with all applicable refrigerants,

i.e. non-sparking, adequately sealed or intrinsically safe.

#### Presence of fire extinguisher

If any hot work is to be conducted on the refrigeration equipment or any associated parts, appropriate fire extinguishing equipment shall be available to hand. Have a dry powder or CO<sub>2</sub> fire extinguisher adjacent to the charging area.

#### Ventilated area

Ensure that the area is in the open or that it is adequately ventilated before breaking into the system or conducting any hot work. A degree of ventilation shall continue during the period that the work is carried out. The ventilation should safely disperse any released refrigerant and preferably expel it externally into the atmosphere.

#### Checks to the refrigeration equipment

Where electrical components are being changed, they shall be fit for the purpose and to the correct specification. At all times the manufacturer's maintenance and service guidelines shall be followed. If in doubt, consult the manufacturer's technical department for assistance.

#### Checks to electrical devices

- ▷ that capacitors are discharged: this shall be done in a safe manner to avoid possibility of sparking;
- ▷ that no live electrical components and wiring are exposed while charging, recovering or purging the system.

#### Repairs to sealed components

During repairs to sealed components, all electrical supplies shall be disconnected from the equipment being worked upon prior to any removal of sealed covers, etc. If it is absolutely necessary to have an electrical supply to equipment during servicing, then a permanently operating form of leak detection shall be located at the most critical point to warn of a potentially hazardous situation.

Particular attention shall be paid to the following to ensure that by working on electrical components, the casing is not altered in such a way that the level of protection is

affected. This shall include damage to cables, excessive number of connections, terminals not made to original specification, damage to seals, incorrect fitting of glands, etc.

- ▷ Ensure that the apparatus is mounted securely.
- ▷ Ensure that seals or sealing materials have not degraded to the point that they no longer serve the purpose of preventing the ingress of flammable atmospheres. Replacement parts shall be in accordance with the manufacturer's specifications.



## NOTICE

The use of silicon sealant can inhibit the effectiveness of some types of leak detection equipment. Intrinsically safe components do not have to be isolated prior to working on them.

### Repair to intrinsically safe components

Do not apply any permanent inductive or capacitance loads to the circuit without ensuring that this will not exceed the permissible voltage and current permitted for the equipment in use.

Intrinsically safe components are the only types that can be worked on while live in the presence of a flammable atmosphere. The test apparatus shall be at the correct rating.

Replace components only with parts specified by the manufacturer. Other parts may result in the ignition of refrigerant in the atmosphere from a leak.

### ● Cabling

Check that cabling will not be subject to wear, corrosion, excessive pressure, vibration, sharp edges or any other adverse environmental effects. The check shall also take into account the effects of aging or continual vibration from sources such as compressors or fans.

### ● Detection of flammable refrigerants

Under no circumstances shall potential sources of ignition be used in the searching for or detection of refrigerant leaks. A halide torch (or any other detector using a naked flame) shall not be used.

### ● Leak detection methods

Leak detection fluids are suitable for use with most refrigerants but the use of detergents

containing chlorine shall be avoided as the chlorine may react with the refrigerant and corrode the copper pipe-work.

### ● Decommissioning

Before carrying out this procedure, it is essential that the technician is completely familiar with the equipment and all its detail. It is recommended good practice that all refrigerants are recovered safely. Prior to the task being carried out, an oil and refrigerant sample shall be taken in case analysis is required prior to re-use of reclaimed refrigerant. It is essential that electrical power is available before the task is commenced.

- A. Become familiar with the equipment and its operation.
- B. Isolate system electrically.
- C. Before attempting the procedure, ensure that:
  - ▷ mechanical handling equipment is available, if required, for handling refrigerant cylinders;
  - ▷ all personal protective equipment is available and being used correctly;
  - ▷ the recovery process is supervised at all times by a competent person;
  - ▷ recovery equipment and cylinders conform to the appropriate standards.
- D. Pump down refrigerant system, if possible.
- E. If a vacuum is not possible, make a manifold so that refrigerant can be removed from various parts of the system.
- F. Make sure that cylinder is situated on the scales before recovery takes place.
- G. Start the recovery machine and operate in accordance with manufacturer's instructions.
- H. Do not overfill cylinders. (No more than 80% volume liquid charge).
  - I. Do not exceed the maximum working pressure of the cylinder, even temporarily.
  - J. When the cylinders have been filled correctly and the process completed, make sure that the cylinders and the equipment are removed from site promptly and all isolation valves on the equipment are closed off.
- K. Recovered refrigerant shall not be charged into another refrigeration system unless it has been cleaned and checked.

**Labelling**

Equipment shall be labelled stating that it has been de-commissioned and emptied of refrigerant. The label shall be dated and signed. For appliances containing flammable refrigerants, ensure that there are labels on the equipment stating the equipment contains flammable refrigerant.

**Recovery**

When removing refrigerant from a system, either for servicing or decommissioning, it is recommended good practice that all refrigerants are removed safely.

When transferring refrigerant into cylinders, ensure that only appropriate refrigerant recovery cylinders are employed. Ensure that the correct number of cylinders for holding the total system charge are available. All cylinders to be used are designated for the recovered refrigerant and labelled for that refrigerant (i.e. special cylinders for the recovery of refrigerant). Cylinders shall be complete with pressure-relief valve and associated shut-off valves in good working order. Empty recovery cylinders are evacuated and, if possible, cooled before recovery occurs.

The recovery equipment shall be in good working order with a set of instructions concerning the equipment that is at hand and shall be suitable for the recovery of all appropriate refrigerants including, when applicable, flammable refrigerants. In addition, a set of calibrated weighing scales shall be available and in good working order. Hoses shall be complete with leak-free disconnect couplings and in good condition. Before using the recovery machine, check that it is in satisfactory working order, has been properly maintained and that any associated electrical components are sealed to prevent ignition in the event of a refrigerant release. Consult manufacturer if in doubt.

The recovered refrigerant shall be returned to the refrigerant supplier in the correct recovery cylinder, and the relevant waste transfer note arranged. Do not mix refrigerants in recovery units and especially not in cylinders.

If compressors or compressor oils are to be removed, ensure that they have been evacuated to an acceptable level to make certain that

flammable refrigerant does not remain within the lubricant. The evacuation process shall be carried out prior to returning the compressor to the suppliers. Only electric heating to the compressor body shall be employed to accelerate this process. When oil is drained from a system, it shall be carried out safely.

# EWPE SMART WI-FI CONTROL APPLICATION

## Wi-Fi app and set up

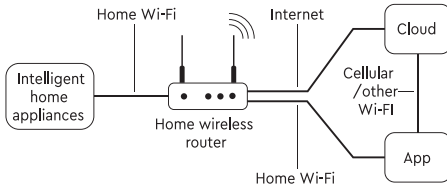

## Download and installation

Scan the QR code or search **Ewpe Smart** in the application



market to download and install it. When the application is installed, register the account and add the device to achieve long-distance control and LAN control of smart home appliances.

For more information, please refer to **Help** in app.

## Set up process

1. Scan the QR code above with your smart phone to download and install the Wi-Fi application directly.
2. Open the Wi-Fi app and click **Sign up** for registration.
3. Sign in through the prompt interface, you can also enter the homepage and click the profile picture at the left upper corner to sign in.
4. Click + at the right upper corner of homepage to add device and select **AC**.
5. After selecting **AC**, you can select different

## Operating systems

Requirement for user's smart phone:



iOS system  
Support iOS7.0 and above version



Android system  
Support Android 4.4 and above version

reset tools according to actual situation. The app interface will provide relevant operation instructions for different tools.

6. Reset the air conditioner (refer to the operation instructions in app interface) and click Next to add home appliance automatically (Wi-Fi password shall need to be inputted).
7. Or after setting and activating the air conditioner, click **Add appliance manually** at the right upper corner to select the wireless network for controlling the device. Then confirm family Wi-Fi and arrange configuration.
8. After finalising device reset and filling in the correct information, search device and arrange configuration.

## Main function settings

In the homepage, click the device in the device list and enter the device into the operation interface.

Set mode, temperature and fan speed to your desired choice.

## Advanced settings

Click **FUNC** in the lower left corner in device operation interface to enter advanced settings

## Swing Settings

Click **Up down swing** or **Left right swing** to turn on or turn off swing function. Click the arrow at the right lower corner of icon to enter the set swing range.

## Preset Setting

Select **Timer** to set preset times of your choice

## Other function settings

### Homepage menu

Click the profile picture at the left upper corner of homepage and set each function in the following menu.

### Scene

Click **Scene** and then you can operate the devices in the preset scene.

### Home management

Click **Home management** to create or manage family. You can also add family members according to the registered account.

### Help

Click **Help** and view the operation instructions of the app.

# SPECIFICATION

Model			CH-S09FTXLA2-NG	CH-S12FTXLA2-NG	CH-S18FTXLA2-NG	CH-S24FTXLA2-NG
Capacity	cooling	kW	2.7	3.51	5.2	7.10
	heating	kW	3.0	3.81	5.6	7.80
Power supply			~ 220-240V/50Hz/1Ph			
Rated capacity	cooling	kW	0.69	0.96	1.58	2.03
	heating	kW	0.70	0.95	1.44	2.0
Air flow rate		m <sup>3</sup> /h	610/570/540/470/ 440/420/390	700/650/600/540/ 480/420/360	850/750/680/610/ 570/520/460	1250/1100/1000/950/ 900/850/800
Sound level rate	IDU (min/ mid/ max)	db(A)	38/36/34/31/29/27/25	42/38/35/32/29/26/25	44/43/41/38/36/34/30	48/44/41/40/38/36/33
	ODU	db(A)	50	52	56	59
Refrigerant type			R32			
Overall dimensions (width/height/ depth)	IDU	mm	845×289×209	845×289×209	970×300×224	1078×325×246
	ODU	mm	732×555×330	732×555×330	802×555×350	958×660×402
Weight	IDU	kg	10.5	10.5	13.5	16
	ODU	kg	24.5	24.5	30.5	41.5
Compressor type			Rotary			
Dehumidification		l/h	1.69	1.4	1.9	2.4
Temperature range	cooling	°C	-15~50			
	heating		-25~30			
Refrigerant volume system		kg	0.53	0.57	0.82	1.5
Liquid line diameter		mm/ inch	6.35/ ¼"	6.35/ ¼"	6.35/ ¼"	6.35/ ¼"
Gas line diameter		mm/ inch	9.53/ ⅜"	9.53/ ⅜"	12.7/ ½"	15.88/ ⅝"
Max. height difference		m	10	10	10	10
Max. piping length		m	15	15	25	25
Distance between fixings		mm	455	455	512	570







\*Cooper&Hunter is constantly working on improvement by pouring their products, so what information given in this manual, may be changed- without prior notice to consumers.

2023/1



66139901783